



Ultraflo U3000/U4000

The new permanent/ fixed clamp-on flow meters from Micronics, for simple, accurate flow measurement from outside the pipe!

The Ultraflo brings simplicity to the non-invasive measurement of liquid flow, offering the user quick and accurate flow measurement with its easy to follow menu and simple set up. A cost-effective alternative to traditional in-line meter installation, plus dry servicing, providing minimum downtime and maximum availability!

Compact, rugged and reliable, the Ultraflow has been designed to provide sustained performance in industrial environments.



- DSP measurement technique
- Reynolds number correction
- Easy to install
- Simple to follow programming menu
- Clamp-on sensors

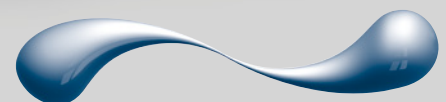
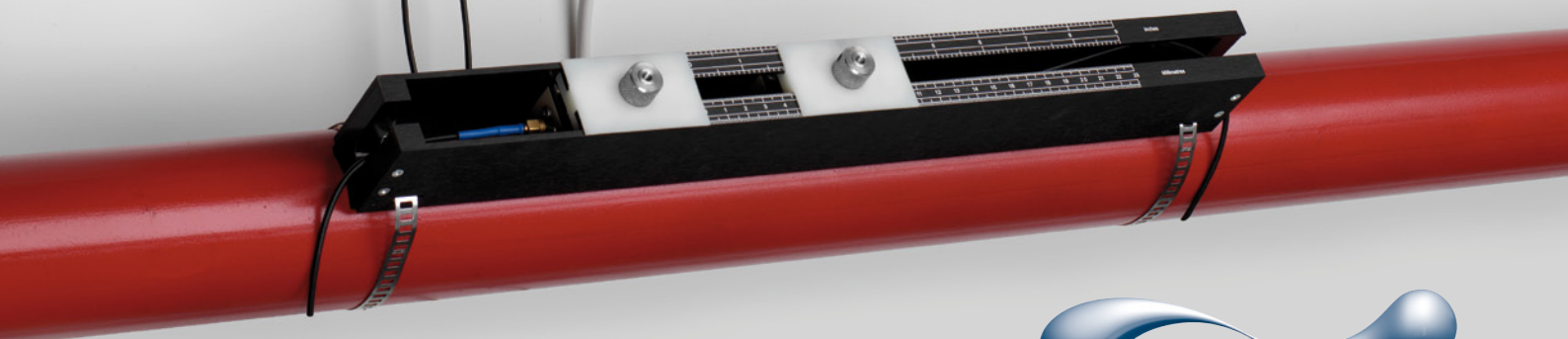

micronics
Through measurement comes control



INDUSTRIES:

- Building Services
- Energy Management
- Water
- Power Generation
- Chemical
- Pharmaceutical
- Petrochemical
- Food

RECOMMENDED FOR:

- Hot water
- Chilled water
- Potable water
- Demineralised water
- River Water
- Hydraulic oil
- Diesel and fuel oils
- Chemicals
- Petroleum products

APPLICATION/USE:

- Hot water metering and flow measurement
- Flow measurement for Heat Metering
- Chilled water metering and flow measurement
- Flow measurement for chilled water energy metering
- Potable water metering and flow measurement
- Process metering and flow measurement
- Ultrapure water measurement
- Heavy fuel oil metering
- Condensate measurement

U3000 - Permanent Ultrasonic Liquid Flow Meter



U3000/U4000 Specification

Enclosure: – The U3000/U4000 enclosure is IP65 rated.

'A' Transducers: – 13mm OD to 115mm OD pipes.

'B' Transducers: – 50mm OD to 2000mm OD pipes.

Optional Transducers: – For pipes 1500mm up to 5000mm contact Micronics.

Transducer Operating Temp: – 'A'&'B' -20°C to +135°C.

Outputs: – Opto Isolated 0/4 –20mA; RS 232/USB (U4000 ONLY); Pulse Output – Programmable Pulse Width from 2ms - 500ms; Two programmable Alarms-High/Low flow, Volume or error.

Data Logger (U4000 ONLY): – Built in data logger with 198,000 data points which can be configured to log flow rate and/or total flow. Real time or stored data can be displayed locally in text or graph format, and downloaded via RS232 or USB port to Windows based PC.

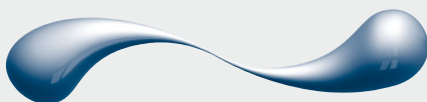
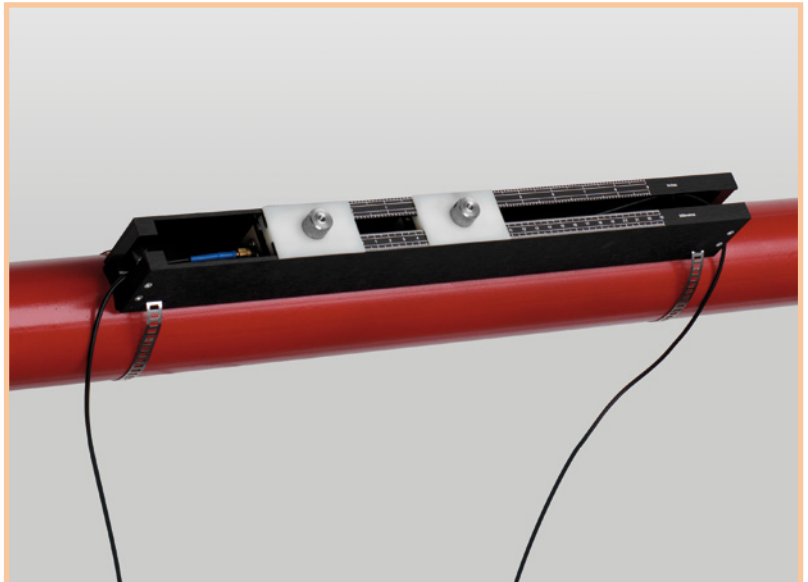

micronics
Through measurement comes control

Ultraflo U3000/U4000

U3000 - Permanent Ultrasonic Liquid Flow Meter



HOW DOES IT WORK?

The Ultraflo is a transit time ultrasonic flow meter designed to work with clamp-on transducers, to provide accurate measurement of liquid flowing within a closed pipe, without the need for any mechanical parts to be inserted through the pipe wall or to protrude into the flow system. It takes just a few minutes to install and there is no need to shut down flow or drain the system!

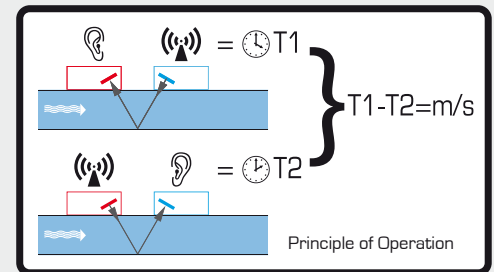

When ultrasound is transmitted between the transducers, the speed at which the sound travels through the liquid is accelerated slightly by the velocity of the liquid through the pipe. When ultrasound is transmitted in the opposite direction, the flow of the liquid causes the transmitted sound to decelerate. The subsequent time difference is directly proportional to the flow velocity in the pipe. Having measured the flow velocity and knowing the pipe cross-sectional area, the volumetric flow can be easily calculated.

U3000/U4000 Product Features

- Flow Range – 0.1m/sec to 20m/sec bi-directional.
- Display – 64 x 240 pixels graphic display.
- Programming is password protected via 15 key control panel.
- Power – 86V to 264V AC. Optional 24V a.c./d.c. 1A max.
- 9 user selectable languages including English, German, French, Spanish and Russian!
- Accuracy +/- 0.5% to +/- 3% depending on pipe size for flow rate > 0.2m/s.
- CE approved

Simple steps for locating sensors on pipe

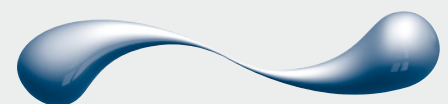
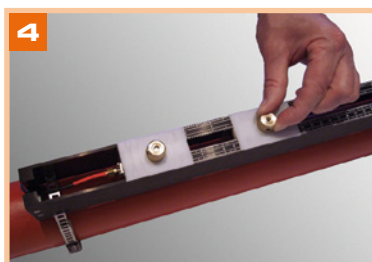
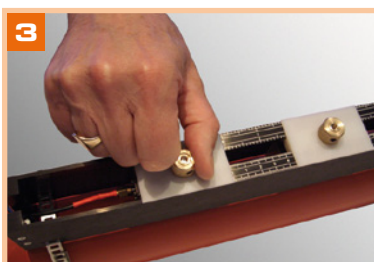
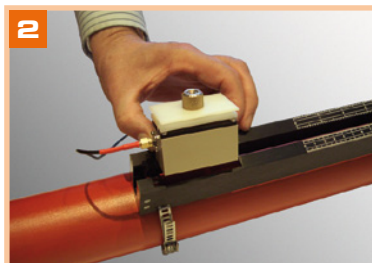
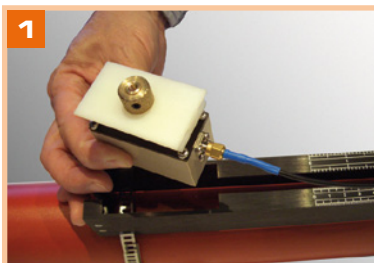

micronics
Through measurement comes control



Ultraflo U3000/U4000

Hardware & Operation

The Ultraflo electronics are housed in a specifically designed IP65 enclosure, which incorporates the graphic display, keypad, sensor and output facility connections. Programming the unit is carried out by selecting the options displayed in the main menu and by following the simple instructions in any of the user selectable languages. Signal strength, time and date, as well as flow information are all continuously displayed, keeping the user fully aware of the measurement process.

Flow Transducers

The Ultraflo is able to work with different transducer sets depending on the unit purchased and the application. Sensors are mounted in a guide rail provided with each instrument, to ensure correct mounting and reliable operation on any size pipe, in either diagonal or reflex mode.

Data Logger (U4000 only)

The built in data logger in the U4000 allows site details and flow data to be recorded with a memory, that is able to log 198,000 separate readings. Data can be stored in 5 second to 1 hour intervals. The data for each site is stored in the memory until it has been cleared. The stored data can be displayed on the instrument in text or graph format. The instrument is also capable of downloading the stored data via the USB or RS232 output port.

Enclosure and guide rail dimensions:

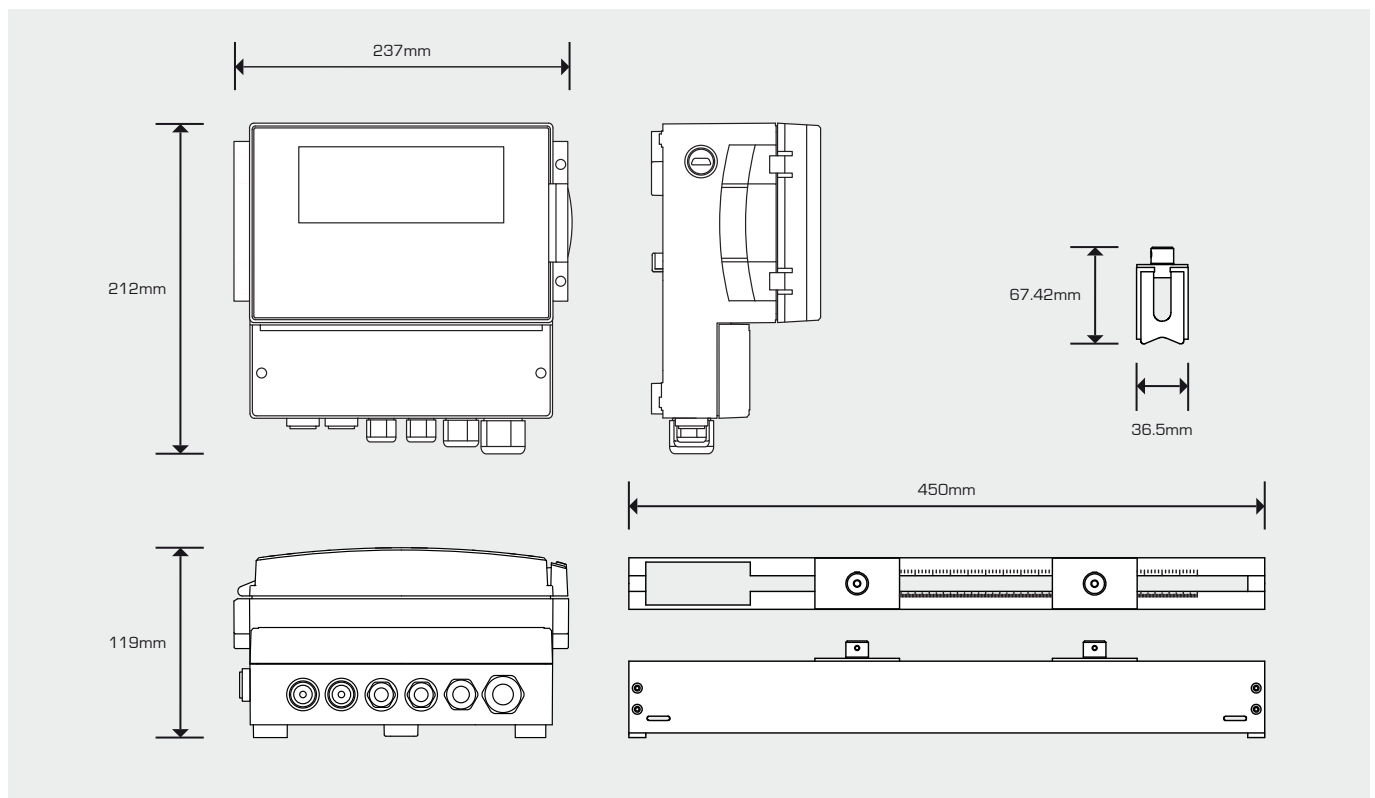

MICRONICS
Through measurement comes control



U3000/U4000 Ultrasonic Flowmeter Technical Datasheet

Description

Utilising advanced DSP technology, the U3000/U4000 is the latest ultrasonic flow measurement and recording system to be added to the Micronics range of equipment.

The U3000/U4000 can display instantaneous fluid flow rates or velocity, together with totalised values. The U4000 also incorporates a data logger that can record up to 200k events which can be output directly to a PC or printer, or stored in the instrument's memory for downloading at a later time.

A variable current or pulse output, proportional to the detected flow rate, enables the system to interface with a range of external control devices such as those found in building management or site monitoring systems.

The U3000/U4000 system is very much designed with 'ease of use' in mind. An interactive QuickStart menu, which simplifies system installation at any suitable location, together with minimal set-up requirements, means that the system can be installed and brought into service very quickly.

The flow sensors, or transducers, connected to the U3000/U4000 instrument are attached to the outside of the pipe being monitored and provide totally non-invasive flow measurement without disturbing the existing plant equipment or process operation.



Application benefits:

- Non-invasive installation – the process operation being monitored is in no way interrupted or otherwise affected by the use of this equipment
- Simple installation – there is no overhead for additional fittings, plant modification, or retro-fit expenditure
- Zero fluid contact – no contamination risks of the process fluid and possible exposure of the monitoring equipment to corrosive or toxic liquids

U3000/U4000 Standard features:

- Large, easy to read graphic display with switchable backlighting
- Flow range 0.1m/sec to 20m/sec bi-directional
- Continuous flow monitoring, with 'Totalised' option
- Two types of transducer sets supplied for use with pipes ranging 13mm - 2000mm outside diameter,
- Operator selectable language
- Simple to follow dual function keypad
- Simple 'Quick Start' set up procedure
- Pulse output (volumetric or frequency)
- 4-20mA, 0-20mA or 0-16mA output with simple range calibration
- Two isolated, programmable alarm outputs

Industries:

- Water
- Building services
- Energy management
- Power generation
- Petrochemical
- Oil/Gas
- Food/drink
- Pharmaceuticals
- Power plants
- Manufacturing

Applications:

- HVAC & energy system audits
- Pump verification
- Metering
- Process control
- Chemical addition
- Hydraulic systems
- Fire systems
- Leak detection
- Boiler testing

U4000 Only:

- Data logging with up to 200k stored data points
- Data logging can be controlled manually or set-up for timed operation, allowing unattended operation
- Logged data can be viewed as text or graphically, with the ability to scroll to any stored event
- RS232/USB outputs for downloading data logger contents to PC or optional printer. Live data logging also available at these outputs
- Both Flow and \pm Totals can be logged

Principles of Operation

When ultrasound is transmitted through a liquid the speed at which the sound travels is accelerated slightly when transmitted in the same direction as the liquid flow and decelerated slightly when transmitted against it. The difference in time taken by the sound to travel over the same distance but in opposite directions is therefore proportional to the flow velocity of the liquid and can be used to calculate the flow rate.

Transit time technique

This technique is known as 'transit time' measurement and is the method used by the U3000/U4000 system to calculate the liquid flow rate. Once the flow velocity is known it is a simple matter for the instrument's software to calculate the volumetric flow.

Operating modes

The ultrasonic sensors can be set to operate in one of four modes determined mainly by the pipe diameter and the transducer set in use. The diagram below illustrates these modes and shows the importance of applying the correct separation distance between the transducers to obtain the best possible signal.

In practice, the U3000/U4000 determines the operating mode and calculates the appropriate transducer separation distance in response to site application data entered by the user.

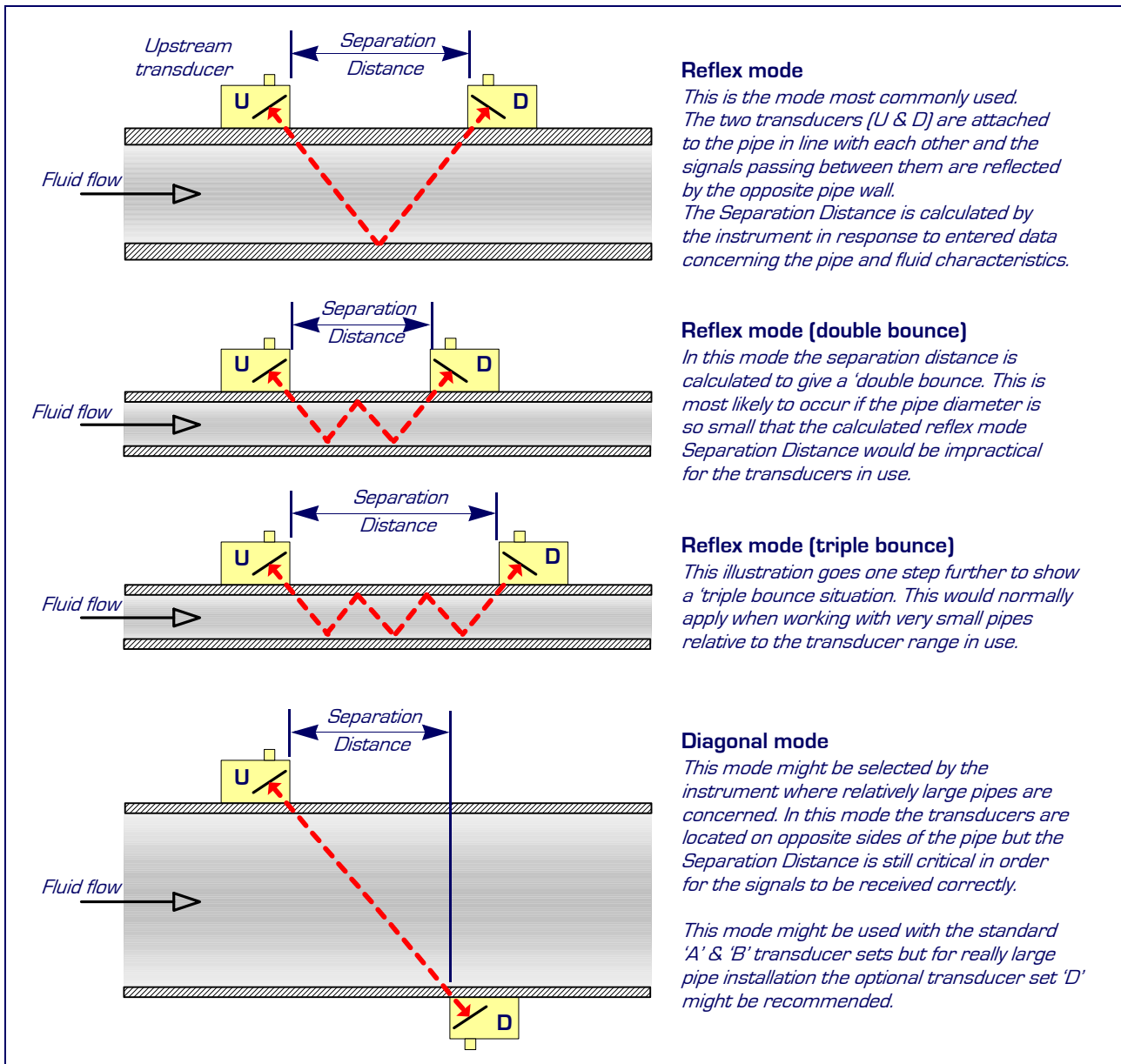

U3000/U4000 System components



Standard equipment

- Instrument with backlit graphic display
- Transducer cables (x2) 5 metres long (longer cable are available)
- Transducers 'A-ST' x2 (U3000/U4000A) for use with pipes ranging 13mm - 115mm
- Transducers 'B-ST' x2 (U3000/U4000B) for use with pipes ranging 50mm - 2000mm
- USB cable and RS232-C cable (U4000)
- Guide rail for use with 'A' or 'B' transducers
- Steel bands used to secure the transducer guide rails to the pipe
- Acoustic couplant
- User documentation

Optional equipment

- Transducer set 'D' - used for monitoring pipes of 1500mm to 5000mm diameter, over a temperature range -20°C to +80°C.

Application site specifications

When setting-up the U3000/U4000 using the QuickStart feature, specific data concerning the pipe construction and fluid conditions must be entered into the instrument in order for it to determine the appropriate transducer mode and fitting details. The parameters that are required to be entered in the QuickStart menu are shown in the tables below, which also illustrate the range and limits of pipe and fluid conditions with which the system can be used.

Pipe material:

Constructed of any sonic conducting medium such as –

- Carbon Steel
- Stainless Steel
- Copper
- UPVC/PVDF
- Mild Steel
- Glass
- Brass
- Concrete

Pipe wall thickness:

The pipe thickness must be in the range of 1mm - 75mm

Pipe diameter:

The maximum permissible pipe outside diameter depends on the type of ultrasonic transducer in use –

- Type 'A' transducer – usable with pipes in the range 13mm to 115mm
- Type 'B' transducer – usable with pipes in the range 50mm to 2000mm
- Type 'D' transducer – usable with pipes in the range 1500mm to 5000mm (optional equipment)

Pipe wall temperature:

The maximum permissible pipe temperature depends on the type of ultrasonic transducer in use –

- Type 'A-ST' (Standard) transducer -20°C to +135°C
- Type 'B-ST' (Standard) transducer -20°C to +135°C
- Type 'D'* transducer -20°C to +80°C

** Note that these transducers are not part of the standard U3000/U4000 kit but can be ordered as optional equipment.*

If the application parameters at the intended site fall outside those shown above, contact Micronics for advice.

Transducers

The U3000/U4000 system is supplied with one set of standard transducers described as 'A-ST' or 'B-ST' (ST = 'Standard'). These transducers are designed for use with pipe diameters ranging from 13mm to 2000mm carrying a fluid with a temperature in the range -20°C to +135°C, which covers the majority of typical site applications. An optional, type 'D', transducer is available for use on pipe diameters up to 5000mm.

A summary of the available transducer specifications is shown in the table below.

Standard transducers:

Temperature range -20°C to +135°C

- 'A-ST' (2MHz) – used with 13mm 115mm pipe o.d.
- 'B-ST' (1MHz) – used with 50mm 2000mm pipe o.d.

Optional transducers:

Temperature range -20°C to +80°C

- 'D' (0.5MHz) – used with 1500 mm...5000 mm pipe o.d.

Transducer mounting

Type 'A' & 'B' transducers are fitted within a guide rail which is secured to the pipe using wrap-around stainless steel bands. A ruler is inscribed on the top of the guide rail to allow the distance between the transducers to be set accurately to the value calculated by the U3000/U4000 instrument.

Once the transducers are correctly positioned they are secured in place by knurled thumbscrews located on the top of the transducer carriers. This illustration shows a completed assembly with both transducers fitted.

The transducers are connected to the U3000/U4000 instrument by means of the 2x5m mini-coaxial cable provided. Bespoke cables of up to 100m can be provided (contact Micronics).



Data logger

The U4000 equipment can record and store up to 200k logged events which can be displayed on the instrument either graphically or as text. Logged data comprises date & timed stamped flow values together with the unit of measurement and can be downloaded to a PC using the inbuilt RS232 or USB interface, or printed to an optional printer. In addition to Flow, the user can select either +Total or -Total (or both) to be displayed. The interval between logged events can be set between 5 secs and 1 hour.

If the memory becomes full the instrument can be configured to either stop logging altogether or continue logging by overwriting the earlier stored data on a first-in first-out basis.

All data is saved to non-volatile memory and is retained in the event of power failure.

When viewing the data in either mode any stored event can be accessed and displayed using the instrument's scroll keys – see the attached illustration.

Logging can be controlled manually using Start/Stop menu options or set to operate automatically on a timer. The timer option is useful if logging is required during unattended operation.

A summary of the data logger specification is shown on the following pages.

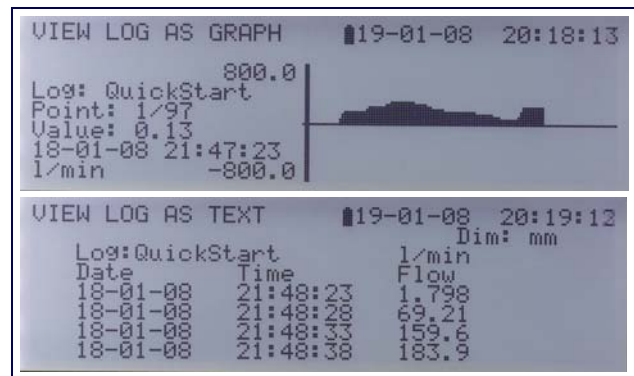

Data logger specification:

Logged data –	Time-stamped flow rate and \pm Totals.
Number of data points –	200,000 (200k) logged events All free memory is allocated by demand.
Programmable logging interval –	5s to 1hr. The screen updates to show the end time of memory remaining as sample units are selected.
Manual/Auto control –	Logging can be started and stopped manually or set for automatic (timer) operation.
Memory overflow –	User selectable to either overwrite old data or stop logging.
Download log –	Logged data can be downloaded to PC using RS232/USB interface (see below). Data can be downloaded directly to facilitate 'live' logging, or recalled from memory to download later.

RS232/USB Output

The U4000 model has a single RS232/USB output facility that can be used to download logged data to a PC or printer. Two, 2 metre interface cables are supplied with the equipment. The RS232 cable is terminated with a standard 9-pin D-type connector suitable for connecting to the serial port of a PC/printer. The USB cable is terminated with a standard USB connector at one end and an IP rated mini-USB connector at the other.

USB interface:

Protocol -	The USB output supports full speed (12Mbits/sec) data connection
Software -	USB driver software is provided

RS232 printer/terminal interface:

Protocol -	The Serial RS-232 communications facilities including XON/XOFF handshaking
Terminal block -	Gnd TxD RxD

Alarm Outputs

Two isolated alarm outputs are provided which can be configured in a number of ways. For example, to operate when the flow rate exceeds a specified maximum or minimum threshold.

The alarm outputs are opto-isolated and connected to the terminal connector block at the bottom of the instrument.

The alarm outputs can also be configured for Pulse Frequency output

Alarm outputs:

Number of Channels:	2 x opto-isolated MOSFET relays.
Isolation:	1500V opto isolated from unit.
Relay Contact Mode:	N/O - switching condition = False Closed - switching condition = True
Alarm Functions:	Configurable to operate when: <ul style="list-style-type: none"> • a predefined minimum flow rate is exceeded • a predefined maximum flow rate is exceeded • a specified volume is measured • a signal error condition occurs • manual alarm test • pulse frequency

Control Outputs

The U3000/U4000 provides analogue and pulse outputs that are designed to be used in conjunction with external control and site monitoring applications such as those typically found in building management systems. These outputs, which are hard-wired to the terminal connector block at the bottom of the instrument, can be calibrated to suit a required flow operating range and high-flow alarm level.

Analogue output:

Range -	4-20mA 0-20mA 0-16mA
Resolution -	0.1% of full scale
Alarm current -	Adjustable between 0-26mA
Isolation -	1000V Opto-isolated
Maximum load -	620 Ohms

Pulse output:

Output type -	One opto-isolated digital MOSFET relay output
Isolation -	1500V opto isolated from unit
Pulse repetition -	User programmable 1 to 250 pps
Pulse width -	User programmable 2ms to 500ms
Max current -	500mA
Max Voltage -	48V

Technical data

General specification:

DSP measurement technique -	The U3000/U4000 uses 'transit time' measurement with a sampling resolution of 50 pico-second, with a continuous signal level indication to the display
Flow velocity range (bi-directional) -	<ul style="list-style-type: none"> • Minimum velocity 0.1m/s - Max velocity 20m/s
Flow measurement accuracy -	<ul style="list-style-type: none"> • $\pm 0.5\%$ to $\pm 3\%$ of flow reading for flow rate $> 0.2\text{m/s}$ and Pipe ID $> 75\text{mm}$ • $\pm 3\%$ of flow reading for flow rate $> 0.2\text{m/s}$ and Pipe ID in range 13mm - 75mm • Flow velocity corrected for Reynolds number over entire velocity range
Repeatability -	<ul style="list-style-type: none"> • $\pm 0.5\%$ of measured value or $\pm 0.02\text{m/s}$ whichever is the greater
Response time -	<ul style="list-style-type: none"> • $< 500\text{ms}$ depending on pipe diameter
Selectable displayed flow units -	<ul style="list-style-type: none"> • VELOCITY: m/sec, ft/sec • VOLUME: l/s, l/min, l/h, gal/min, gal/h, USgals/min, USgals/h, Barrel/h, Barrel/day, m³/s, m³/min, m³/h
Selectable displayed volume units -	<ul style="list-style-type: none"> • litres, m³
Total volume -	<ul style="list-style-type: none"> • 12 Digits - forward and reverse
Display languages -	<p>The following languages can be selected from the U3000/U4000 set-up menu</p> <ul style="list-style-type: none"> • English • French • German • Italian • Portuguese • Swedish • Spanish • Norwegian • Russian • Dutch

Electrical

Two cable glands, one M16 and the other M20, are provided on the bottom right-hand side of the instrument for the power supply cable. These can accept cables of 10mm (M16) and 14mm (M20) diameter respectively.

Supply voltage:

Input mains supply -	86V to 264V a.c. (47Hz to 63Hz)	Power consumption -	10.5W
Alternative DC supply -	24Va.c*/.d.c. 1A max. [*24V ac supply must be isolated from earth]		

Mechanical & miscellaneous data.

Instrument enclosure:

Material -	ABS and aluminium
Dimensions -	230mm x 180mm x 120mm
Weight -	1.2 kg
Number of Keys -	15 key tactile feedback membrane keypad
Display -	240 x 64 pixel graphic display, high contrast black-on-white, with backlight. Viewing angle: Min 30°, typically 40° Active area: 127mm x 34mm
IP Rating -	IP65

Shipping information:

Box dimensions -	480mm x 320mm x 150mm
Weight -	4.5 kg
Volumetric weight:	3.8 kg

Environmental:

Operating temperature -	-20°C to +50°C
Storage temperature -	-25°C to +75°C
Operating humidity -	90% RH MAX at +50°C

Approvals:

Safety -	BS EN 61010-1:2001
EMC -	BS EN 61326-1:2006, BS EN 61326-2-3:2006
Environmental -	BS EN 60068-1:1995, BS EN 60068-2-1:2007, BS EN 60068-2-2:2007

U3000/U4000 Installation Detail

Mounting Details

The instrument should be securely wall-mounted using the three fixing points shown.

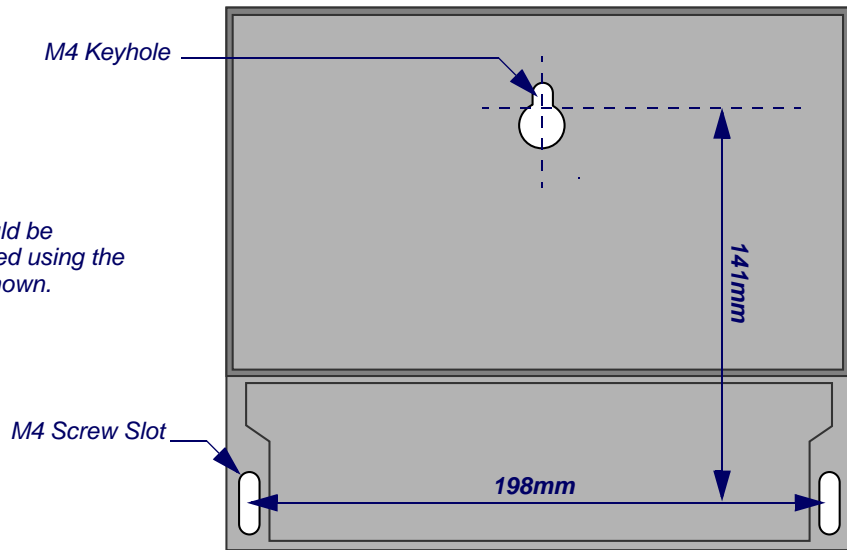

Cable connections

All power and control cables enter through cable glands located on the bottom of the instrument and connect to terminal blocks as shown.

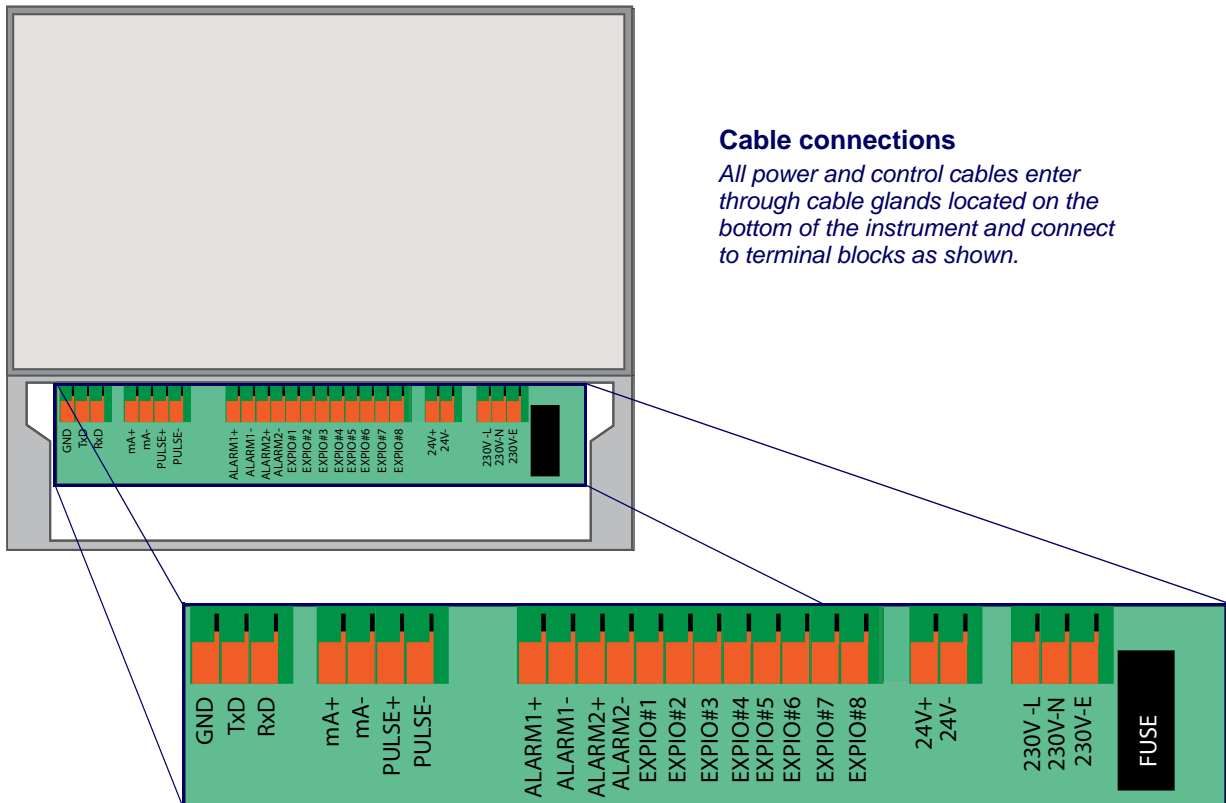

Micronics reserve the right to alter any specification without notification